

ATTACHMENTS DISTRIBUTED UNDER SEPARATE COVER

CCL 26/09/23 - EXHIBITION OF DRAFT OUTDOOR TRADING POLICY

8.1 Attachment A: Draft Outdoor Dining Policy

8.1 Attachment B: Draft Outdoor Dining Guidelines

DISTRIBUTED UNDER SEPARATE COVER

INTENTIONAL BLANK PAGE

DISTRIBUTED UNDER SEPARATE COVER

Outdoor Dining Policy

September 2023

newcastle.nsw.gov.au



City of
Newcastle

Table of Contents

| | | |
|---------------|--|----------|
| Part A | Preliminary..... | 1 |
| 1 | Purpose | 1 |
| 2 | Scope..... | 1 |
| 3 | Principles..... | 1 |
| Part B | Roles and Responsibilities..... | 2 |
| 4 | Applicants and Permit Holders | 2 |
| 5 | CN Officers | 2 |
| Part C | Approvals..... | 2 |
| 6 | Legislative Context..... | 2 |
| 7 | Outdoor Dining Guidelines..... | 2 |
| Part D | References | 3 |
| Part E | Annexures..... | 3 |
| | Annexure A - Definitions | 3 |
| | Annexure B - Policy Authorisations..... | 4 |
| | Document Control..... | 5 |

Part A Preliminary

1 Purpose

- 1.1 The purpose of the Outdoor Dining Policy ([this] Policy) is to provide the framework for the establishment and operation of outdoor dining and associated approval(s).
- 1.2 Facilitate the creation of a vibrant cosmopolitan atmosphere in appropriate areas of the city and surrounding suburbs.
- 1.3 Encourage the appropriate use of footways for the purposes of outdoor dining to stimulate business growth and development.
- 1.4 Ensure footways are safe and equitable for all people, including pedestrians with a pram or mobility aid, people who are vision impaired and users of wheelchairs and scooters.
- 1.5 Promote the creation of streets which are amenable and attractive for locals and visitors.
- 1.6 Provide opportunities for shop owners, residents, and visitors to benefit from pedestrian circulation.
- 1.7 Provide requirements and guidelines for outdoor dining to minimise disruption to neighbours, pedestrians, and other street users.

2 Scope

- 2.1 The policy applies to all applications for outdoor dining on footways within the Newcastle local government area.
- 2.2 Outdoor dining comprises premises wanting to operate a footway dining area and requires an approval in accordance with Section 125 and Section 126 of the Roads Act 1993.
- 2.3 This policy does not apply to mobile food vending vehicles. Anyone seeking approval to operate a mobile food vending vehicle must apply to City of Newcastle (CN) for a permit in accordance with CN's Mobile Food Vending (Local Approvals) Policy.
- 2.4 This policy does not apply to other activities wanting to be conducted on a roadway or in any other public place e.g. public park, and any person wishing to undertake those activities should contact CN and seek advice about the appropriate permit and/or approvals process.
- 2.5 The information in this policy outlines the requirements CN considers when assessing outdoor dining applications and regulating outdoor dining activities.

3 Principles

- 3.1 CN commits itself to the following:
 - a) **Retain accessibility and utility of outdoor public spaces** – ensure that the primary purpose of the footway shall be kept as a pedestrian thoroughfare, retain a consistent and clear path of travel for all users of footways, and ensure that the usability of footways is not unduly constrained by outdoor dining.
 - b) **Provide value and amenity to the City** – provide a framework to ensure recognition and maximisation of the value of Outdoor Dining venues, while minimising potential negative impacts.
 - c) **Ensure compliance with legislation and policies** – ensure public safety of Outdoor Dining operations, through granting approval for the use of footways and conducting compliance monitoring at venues.
 - d) **Align with Council strategies** – This Policy aligns with the strategic direction of the Newcastle 2040 Strategic Plan through providing enriched neighbourhoods and places and supporting a strong local economy, with safe and equitable access for all users.

Part B Roles and Responsibilities

4 Applicants and Permit Holders

- 4.1 It is the responsibility of Applicants to provide all requisite information on application forms and pay any application fees liable in order to have an application assessed by CN.
- 4.2 It is the responsibility of Approval Holders to ensure that outdoor dining operations are always conducted in a safe and hygienic manner, and that footpath user mobility is not constrained by outdoor dining operations.
- 4.3 Approval Holders must ensure that all conditions of approval, the current Outdoor Dining Guidelines and relevant legislation are complied with at all times.

5 CN Officers

- 5.1 CN Officers with suitably delegated authority are responsible for reviewing applications for completeness, assessing applications received in accordance with this Policy and related legislation and guidelines, and enforcing compliance with this Policy and related guidelines and approvals in accordance with the CN's Compliance and Enforcement Policy.

Part C Approvals

6 Legislative Context

In order for venues to use a footway for outdoor dining, the following approvals are necessary under State legislation:

- all outdoor dining on the footpath requires approval under the *Roads Act 1993*.
- outdoor dining that is not exempt development under State Environmental Planning Policy (Exempt and Complying Development Codes) 2008 will require a development application under the *Environmental Planning and Assessment Act 1979*.

7 Outdoor Dining Guidelines

This Policy aligns with CN's Outdoor Dining Guidelines. The Guidelines provide additional information on the requirements for outdoor dining in a footway and the responsibilities of an approval holder in terms of maintaining and enhancing the local character, heritage, ambience and safety of the public domain. An assessment of Outdoor Dining Applications shall be made against these Guidelines, however in the event of any inconsistency between the Policy and Guidelines, the Policy shall prevail.

The final decision on whether any given application shall receive approval shall remain at CN's sole discretion on land it owns or otherwise controls.

Part D References

This Policy references the following pieces of State and Federal Legislation:

- Disability Discrimination Act 1992 (Cth)
- Environmental Planning and Assessment Act 1979
- Local Government Act 1993
- Roads Act 1993
- State Environmental Planning Policy (Exempt and Complying Development Codes) 2008

In preparing this Policy, the following documents were reviewed:

- CN Mobile Food Vending (Local Approvals) Policy V3 February 2023

Part E Annexures

Annexure A - Definitions

Applicant means the entity (business or person) seeking approval for an Outdoor Dining Permit.

Approval means an approval granted by Council under section 125 or 126 of the Roads Act 1993; section 68 of the Local Government Act 1993; a condition of development consent under the Environmental and Assessment Act; or any other valid written agreement entered into with Council and the Approval Holder.

Approval Holder means the entity (business or person) to which an Approval has been granted.

CEO means Chief Executive Officer of the City of Newcastle and includes their delegate or authorised representative.

References to the Chief Executive Officer are references to the General Manager appointed under the *Local Government Act 1993* (NSW).

City of Newcastle (CN) means Newcastle City Council.

CN Officers means employees of CN (including full time, part time, fixed term and casual) or Specific Talent Contractor who is engaged under a CN position description.

Guidelines means the associated Outdoor Dining Guidelines document.

Footway means the area adjacent the public road.

[This] Policy means the Outdoor Dining Policy document.

Unless stated otherwise, a reference to a section or clause is a reference to a section or clause of This Policy.

Annexure B - Policy Authorisations

In accordance with section 378 of the Local Government Act 1993, the Chief Executive Officer delegates the following functions to the positions listed:

| Title of authorisation | Description of authorisation | Position Number and Title |
|---|--|--|
| Authority to use footway for restaurant | Authority to determine an application for a footway dining approval. Pursuant to Section 125 of the Roads Act 1993. | Refer to CN Delegation Register due to the number of positions with this delegation. |
| Authority to erect structures | Authority to authorise the holder of a footway dining approval to erect and maintain structures in, or over any part, of the footway. Pursuant to Section 126 of the Roads Act 1993. | Refer to CN Delegation Register due to the number of positions with this delegation. |
| Footway restaurants | Authority to grant an approval pursuant to Part 9 Division 1 of the Roads Act 1993 to use part of a footway for the purposes of a restaurant and to authorise a holder of an approval to erect and maintain structures in, on or over any part of the footway the subject of the approval. | Refer to CN Delegation Register due to the number of positions with this delegation. |

Document Control

| | |
|--|--|
| Policy title | Outdoor Dining Policy |
| Policy owner | Executive Director of Planning and Environment |
| Policy expert/writer | City Wide Development Assessment Manager |
| Associated Guideline or Procedure Title | Outdoor Dining Guidelines |
| Guideline or Procedure owner | Executive Director of Planning and Environment |
| Prepared by | Planning and Environment |
| Approved by | Council |
| Date approved | TBC |
| Commencement Date | TBC |
| Next review date | Within the first 12 months of the new Council term |
| Termination date | One year past the review date |
| Version # | Version number 1 |
| Category | Planning, Development and Local Approvals |
| Details of previous versions | Version 1 – ECM: |
| Keywords | Planning, Approvals, Outdoor, Dining |
| Relevant Newcastle 2040 Theme/s | Liveable Sustainable Creative Achieving Together |
| Relevant legislation/codes (reference specific sections) | This Policy supports CN’s compliance with the following legislation: <ul style="list-style-type: none"> – Environmental Planning and Assessment Act 1979 – State Environmental Planning Policy (Exempt and Complying Development Codes) 2008 – Roads Act 1993 – Local Government Act 1993 – Crown Land Management Act 2016. |
| Other related documents | Outdoor Dining Guidelines |
| Related forms | Outdoor Dining Application |
| Required on website | Yes |
| Authorisations | Functions authorised under this Policy at Annexure B |

INTENTIONAL BLANK PAGE

DISTRIBUTED UNDER SEPARATE COVER

City of Newcastle

Outdoor Dining Guidelines



City of
Newcastle

Acknowledgement

The City of Newcastle acknowledges the traditional country of the Awabakal and Worimi peoples.

We recognise and respect their cultural heritage, beliefs and continuing relationship with the land, and that they are the proud survivors of more than two hundred years of dispossession.

Council reiterates its commitment to addressing disadvantages and attaining justice for Aboriginal and Torres Strait Islander peoples of this community.

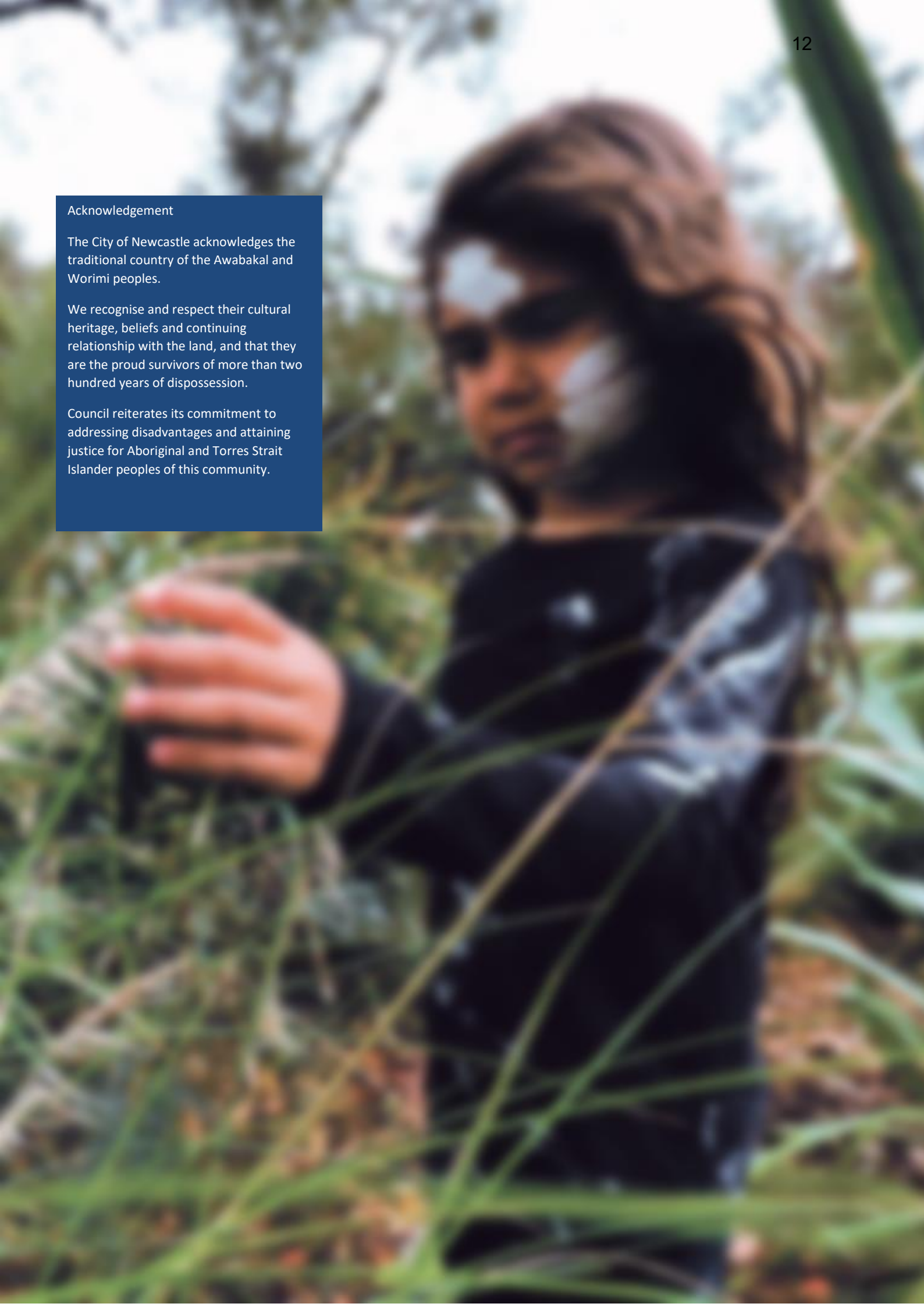

Table of Contents

| | |
|---|-----------|
| 1. Introduction..... | 1 |
| Guiding principles | 1 |
| Where does this guide apply? | 1 |
| Definitions | 1 |
| 2. Determining the Dining Area..... | 3 |
| Objectives | 3 |
| Site requirements | 3 |
| Site plan 3 | |
| Outdoor dining area placement | 3 |
| Intersections | 6 |
| 3. Design and Furnishing | 7 |
| Objectives | 7 |
| Placement of furniture and objects | 7 |
| Chairs and tables | 8 |
| Waiter stations | 8 |
| permanent furniture and objects | 8 |
| Barriers / screening | 9 |
| Heating | 9 |
| Temporary Signage | 11 |
| Weather protection | 11 |
| 4. Amenity..... | 12 |
| Objectives | 12 |
| Smoking 12 | |
| Service of alcohol..... | 12 |
| Hours of operation | 12 |
| Music & noise | 12 |
| Lighting 12 | |
| Heritage 12 | |
| Management | 12 |
| Animals in outdoor dining areas..... | 12 |
| 5. Application | 13 |
| Application requirements..... | 13 |
| Fees for application | 13 |
| Other approvals | 13 |
| Insurance | 14 |
| 6. Assessment Process | 15 |
| Assessment considerations | 15 |
| 7. Conditions of approval | 16 |
| General | 16 |
| Compliance | 17 |
| Appendix A: Site Plan Requirements | |
| Appendix B: Plan of Management Requirements | |

1. INTRODUCTION

All outdoor dining on public land requires approval. These guidelines are to be read with the City of Newcastle's (CN's) Outdoor Dining Policy which details the different approvals that may be required for outdoor dining.

These guidelines describe the design and approval requirements when using a public footway for outdoor dining. Variation to these guidelines may be approved where the outcome of the variation achieves the principles and objectives of this document and its provisions.

These guidelines:

- Detail the responsibilities of the business when using a public footway for the provision of outdoor dining.
- Provide businesses with a straight-forward guide for the location, design and application requirements for outdoor dining.
- Provide guidance for CN officers in assessing applications for use of the footway for outdoor dining.
- Facilitate the creation of a vibrant cosmopolitan atmosphere supporting local economic development and streetscape activation in appropriate locations.

GUIDING PRINCIPLES

These guidelines specify locations and layout considerations for outdoor dining. The overarching objectives within are devised to meet the intent of the CN Outdoor Dining Policy and to:

- Retain accessibility and utility of outdoor public spaces.
- Achieve safety of all road users and diners.
- Maintain amenity of the public domain and neighbourhood.

WHERE DOES THIS GUIDE APPLY?

These guidelines apply to all applications for outdoor dining on a public footway, requiring a permit in accordance with Section 125 or Section 126 of the *Roads Act 1993*, in the City of Newcastle Local Government Area.

These guidelines do not apply to mobile food vending vehicles. Anyone seeking approval to operate a mobile food vending vehicle must apply to CN for a permit in accordance with CN's Mobile Food Vending (Local Approvals) Policy.

These guidelines do not apply to other activities conducted in a roadway, or dining in other public places e.g. public park. Any person wishing to undertake those activities should contact CN and seek advice about the appropriate permit process.

This guide does not negate other requirements for outdoor dining, including any other approval or licence. It is the owner's responsibility to comply with any liquor licence and development application (DA) conditions or exempt development provisions. In the event of any inconsistency, the DA conditions and liquor licence will prevail over this document.

DEFINITIONS

Approval - an approval granted by CN under section 125 or 126 of the *Roads Act 1993*; section 68 of the *Local Government Act 1993*; a condition of development consent under the *Environmental and Assessment Act 1979*; or any other valid written agreement entered into with CN and the operator.

Approval Holder means the entity (business or person) to which an Approval has been granted, referenced generally in this document as 'the operator'.

CN (City of Newcastle) - Newcastle City Council.

Classified Road – a road classified under the *Roads Act 1993* and as defined in the Schedule of Classified Roads and Unclassified Regional Roads by Transport for New South Wales (TfNSW).

CN officers - employees of CN (including full time, part time, fixed term and casual) or Specific Talent Contractor who is engaged under a CN position description.

DA conditions – Conditions of Development Consent.

Exempt development – Development that does not require DA consent under the *Environmental Planning and Assessment Act 1979*. At the time of adoption, the *State Environmental Planning Policy (Exempt and Complying Codes) 2008* makes footway dining exempt development if it is:

- Carried out in accordance with an approval granted under section 125 of the *Roads Act 1993*, including in accordance with any hours of operation to which the approval is subject, and
- Carried out in accordance with any approval granted under section 68 of the *Local Government Act 1993*, and
- Not under an awning, unless the awning complies with the requirements set out in the Building Code of Australia, Volume 1, B1P1 and B1P2.

Food or drink premises - premises that are used for the preparation and retail sale of food or drink (or both) for immediate consumption on or off the premises, and includes a restaurant or cafe, take away food and drink premises, a pub or a small bar.

Footway – a footway is the part of a road used for pedestrian traffic (whether or not it may also be used by bicycle traffic).

Outdoor dining - for the purpose of this guideline means dining on a public road or footway.

Outdoor dining area – a part of the footway, utilised for dining in association with an adjacent approved business.

The outdoor dining area is depicted in the light blue area of the **Figure 1-1** below.

Parklet - a small seating area or green space created as a public amenity on or alongside a pavement, or in a former roadside parking space.

Pedestrian zone – unobstructed access area of at least 1.8m.

Public domain - includes roads, streets, footways, laneways, malls, squares, plazas, parks, reserves and car parks owned, operated, or managed by the City of Newcastle.

Venue – The adjacent approved business under which the outdoor dining is trading.

Unless stated otherwise, a reference to a chapter or clause is a reference to a chapter or clause of this Policy.

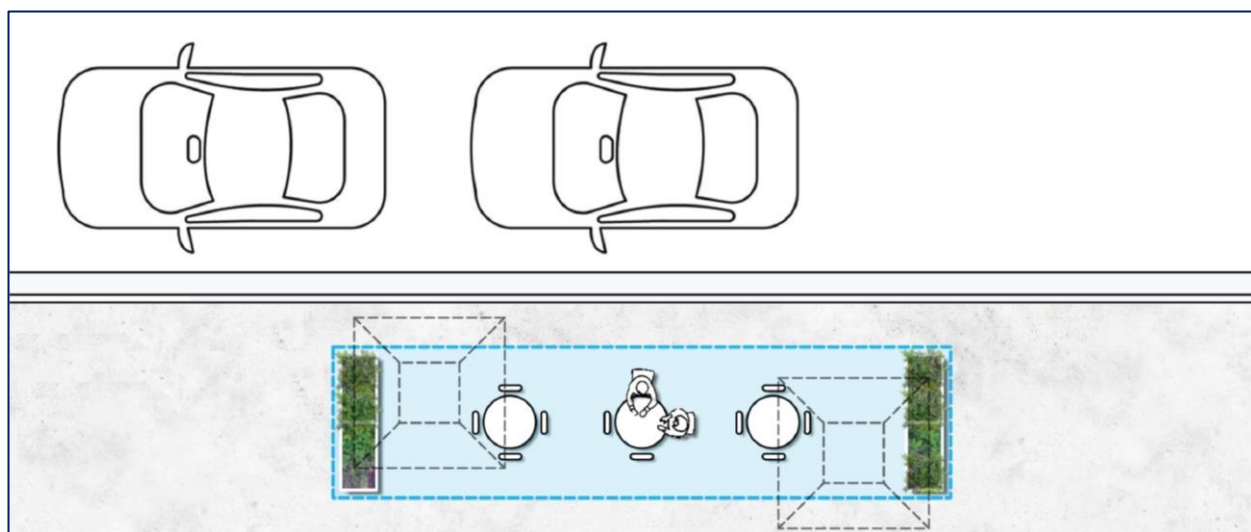

Figure 1-1 Outdoor dining area is depicted in blue

Outdoor dining barriers – movable physical barriers that separate the outdoor dining area from other parts of the footway. 'End barriers' typically separate one venue from another. 'Pedestrian zone barriers' separate it from the pedestrian footway. 'Kerbside barriers' separate the area from the road and vehicular traffic.

Operator / Outdoor dining operator – the entity that holds the approval (approval holder) and exercises management and control over an outdoor dining area used for the purpose of outdoor dining.

2. DETERMINING THE DINING AREA

OBJECTIVES

The outdoor dining area must provide a safe and uncluttered area for diners as well as providing a safe, unobstructed passageway for other road users including pedestrians, cyclists, drivers and persons with a disability.

An outdoor dining area is most appropriate where:

- The public space is wide enough to accommodate the outdoor dining area while still maintaining a clear pathway of travel, minimum 1.8m in width for all pedestrians, including those who use mobility aids.
- It does not restrict lines of sight for motorists and pedestrians.
- There is no unreasonable hazard to pedestrians, users of dining areas or vehicular traffic.
- Streets have a minimum paved footway width of 3.4m.
- The dining area can be seen and supervised by staff inside the venue.

SITE REQUIREMENTS

2.1 An outdoor dining area will only be considered by CN where:

- It is located on a public road reserve or footway.
- It is in association with an approved food or drink premises that is adjacent to the footway, and where that business operator is the applicant.
- Has a suitable gradient for outdoor furniture and use by diners.
- The speed limit is 60kmph or less.
- If the speed limit is 50 or 60 kmph, outdoor dining is only permitted where the footway adjoins a parking or cycling lane, rather than a moving traffic lane.
- If proposed adjoining a moving traffic lane, a risk assessment will be undertaken by CN as part of the application.
- If proposed on a State road or within 20m of traffic controls signals, agreement is required from Transport for NSW. CN will consult with Transport for NSW as part of the assessment process.
- Where laneways are closed or temporarily closed to traffic, a minimum clear width of 1.8m for pedestrian

circulation is required. Consistency with any neighbouring dining areas should be considered.

2.2 In areas of high pedestrian volume or where close proximity to traffic may pose a safety risk, CN may:

- Require greater clearances than shown in Clauses 2.6; or
- Not allow outdoor dining, if the street is identified as not suitable.

2.3 An application may seek to extend beyond the approved business frontage (e.g. within the footway of an adjacent business), with consent from the adjoining business. A merit-based assessment will be undertaken and will have regard to amenity and other impacts.

SITE PLAN

2.4 A location and site plan must be provided (see example at **Appendix A:**), showing:

- Location of the venue and neighbouring premises.
- Location of doorways, windows and service openings.
- Location of any road, lane or cycleway.
- Location of any bus stops, taxi stand, kerbside parking areas, loading zones, pedestrian crossings and street intersections (if any).
- Location of any existing fixed objects such as trees, seats, bins, bike racks, street signs or plantings.
- Defined outdoor dining area and dimensions.
- Placement of all proposed objects within the outdoor dining area.
- Compliance with the clearance / distances outlined in these guidelines.

OUTDOOR DINING AREA PLACEMENT

2.5 Outdoor dining is to be generally located adjacent to the road kerb in accordance with **Figure 2-1**, to optimise accessibility along the building line in accordance with the Australian Standards and the *Disability Discrimination Act 1992*. An independent access report will be required to support the application if the outdoor dining area does not provide a clear path of travel along the building line.

2.6 An unobstructed pedestrian path of travel, with a minimum width of 1.8m, is to be provided along the footway, refer to **Figure 2-2**. The 1.8m is to be fully

clear of existing street fixtures, such as seats, bench, tree, garbage bin, poles.

- 2.7 The minimum distance from the kerb to the dining area is 600mm based on a kerbside parallel parking arrangement.
- Additional clearances are required for dining areas in proximity to bus stops, taxi zones, loading zones or construction zones, angle parking, rear to kerb, disabled parking.
 - In these special circumstances CN will provide advice on appropriateness of outdoor dining and setbacks on a case-by-case basis to provide for a safety buffer from vehicles and to enable passengers to alight from and access parked vehicles.
- 2.8 Where there are consecutive outdoor dining establishments, a 500mm separation is required at either end of the outdoor dining area (i.e. of each premises) to ensure access points are maintained between the pedestrian zone and the road.

The dining area should not inhibit access to fire services and other essential services and public utilities such as access holes, inspection chambers, telephone and electricity underground cables, water service pipes and the like. Access to such services to enable maintenance work or the like by contractors during trading hours is to be prioritised.

- 2.9 The dining area must provide a minimum of one metre clearance from public utilities (examples listed in 2.7 above) and street infrastructure (garbage bins, public seating, bicycle racks and other public domain furniture). A minimum 750mm clearance is required for trees, bollards, kerb ramps, driveways, and poles.



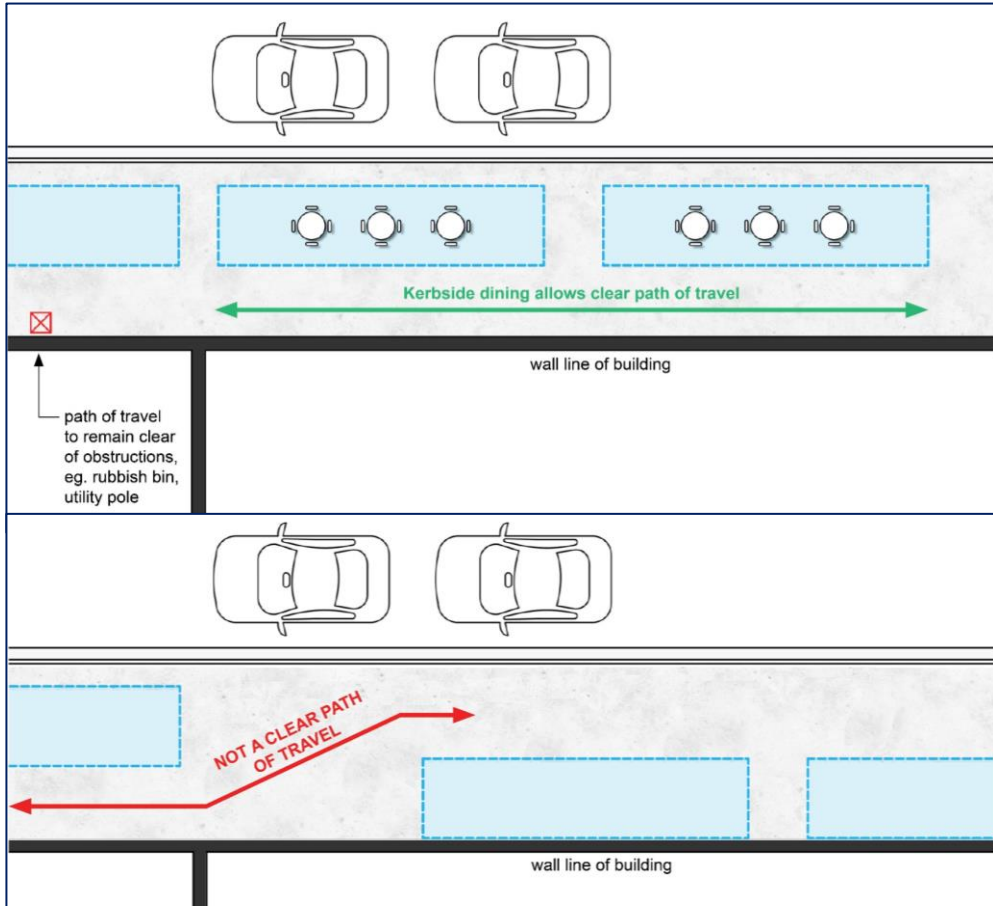

Figure 2-1 Minimum dimensions within footway to accommodate outdoor dining area

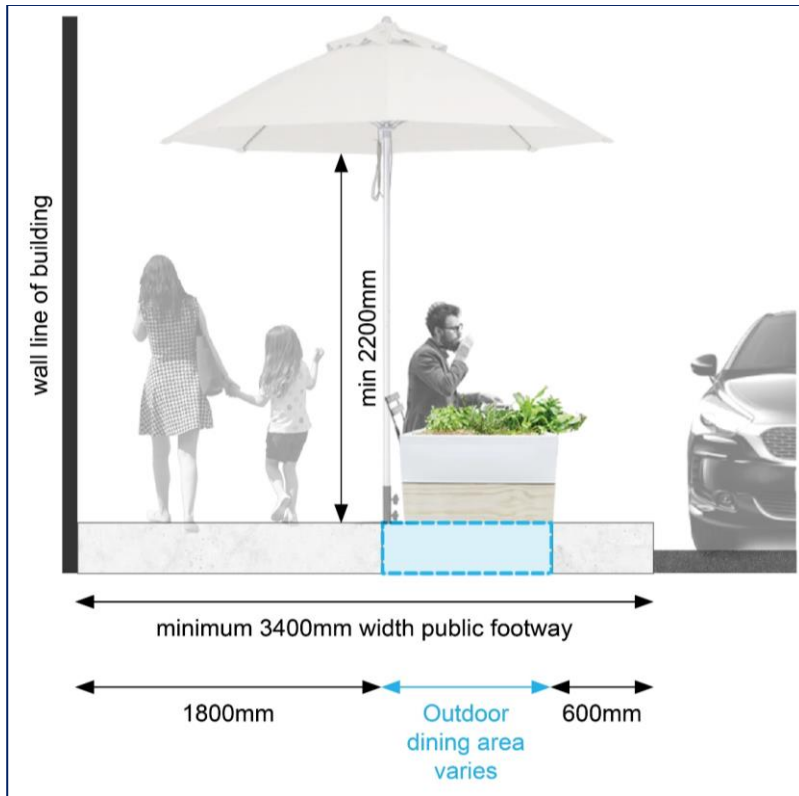

Figure 2-2 Footway to be located kerbside and to provide a clear path of travel

INTERSECTIONS

It is important to ensure that outdoor dining areas are adequately set back from intersections to provide suitable pedestrian circulation space, clear sightlines, appropriate clear zones and safe conditions for all road users around intersections.

2.10 Generally, a minimum setback of 3m as measured from the corner of the building line will be required (see **Figure 2-1**).

- Increased setbacks may be required at some locations due to factors including intersection alignment, crash history or building proximity to the roadway. The required setback will vary depending on factors such as the type of intersection and the level and speed of vehicular traffic.

- At some locations reduced setbacks may be permitted having regard to the sight lines present at the location.
- Site specific considerations may apply to corner sites following assessment by CN's Traffic Engineers.

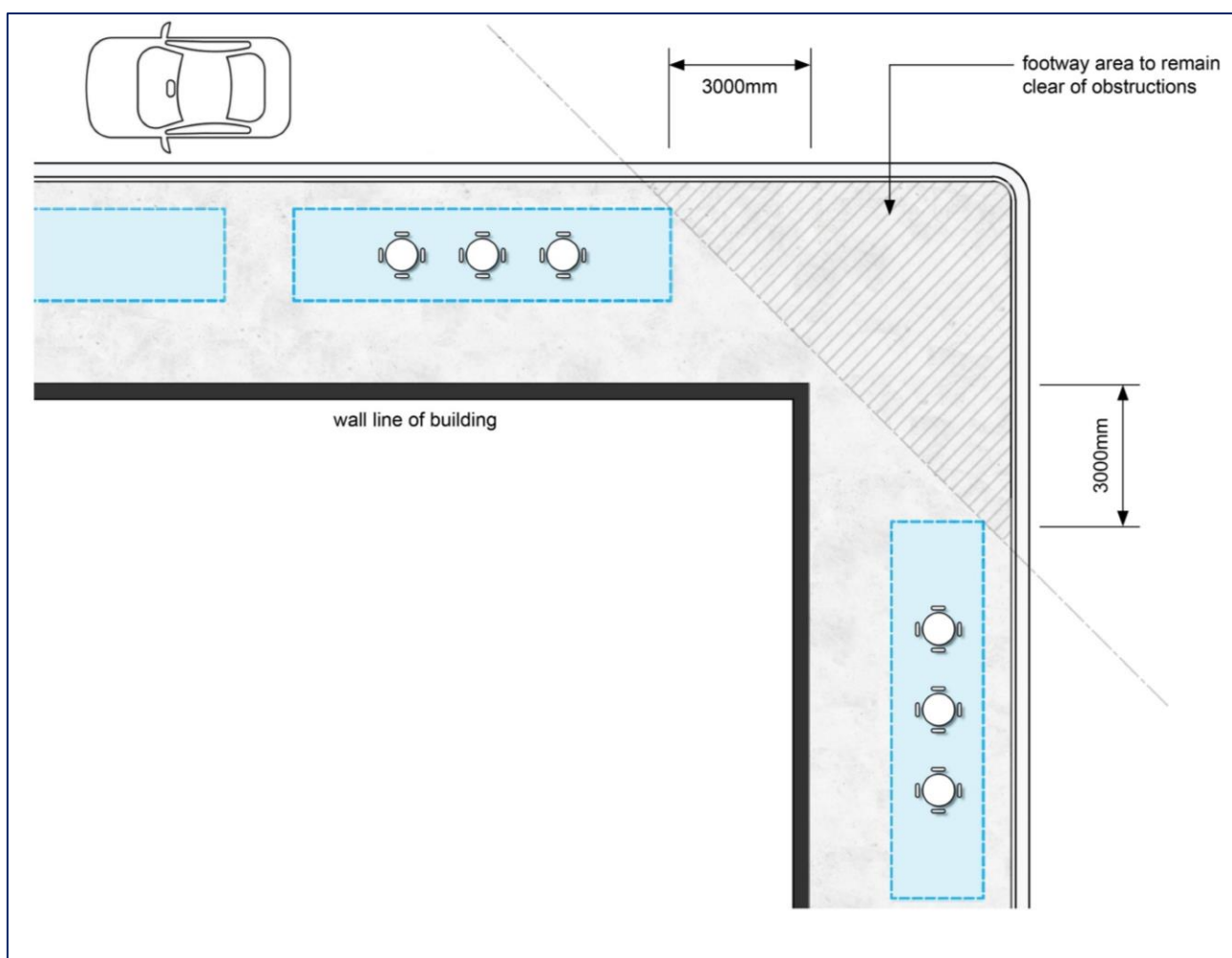

Figure 2-1 Outdoor dining requirements at corner sites/intersections

3. DESIGN AND FURNISHING

OBJECTIVES

While outdoor dining can be a positive addition to the vibrancy of an area, it is important to retain the primary function of the public footway - to provide access to pedestrians and other users of all abilities to travel along the public footway.

The placement of furniture and objects must be temporary. A safe, clutter free environment must be provided, with sufficient space for movement of diners and staff, whilst remaining within the confines of the nominated outdoor dining area. Furniture is to be durable and contributing to the streetscape and character.

In some circumstances the footway is not suitable for outdoor dining as the footway as it is too narrow or too busy to support a business use and/or provide the clear path of travel.

In this chapter 'furniture' relates to all items within the outdoor dining area and is used interchangeably with the term 'objects'.

PLACEMENT OF FURNITURE AND OBJECTS

- 3.1 All furniture and objects need to be easily moved and stored inside after close of business, each day.
- 3.2 Objects that are left on the footway after the approved operating times of the outdoor dining area are regarded as 'Permanent Furniture and Objects'. A separate approval is required under section 126 of the Roads Act 1993 for permanent structures.
- 3.3 Outdoor dining furniture is to provide access to patrons of all abilities and be flexible to accommodate wheelchairs and mobility devices.
- 3.4 Outdoor dining furniture (including when seats are being used) and objects shall not protrude outside the designated area. The only exception is umbrella canopies, which may encroach the footway, as long as compliant with the minimum height clearances. No encroachments onto a roadway or cycleway are permitted. The outdoor dining area will be marked by CN. See **Figure 3-1**.

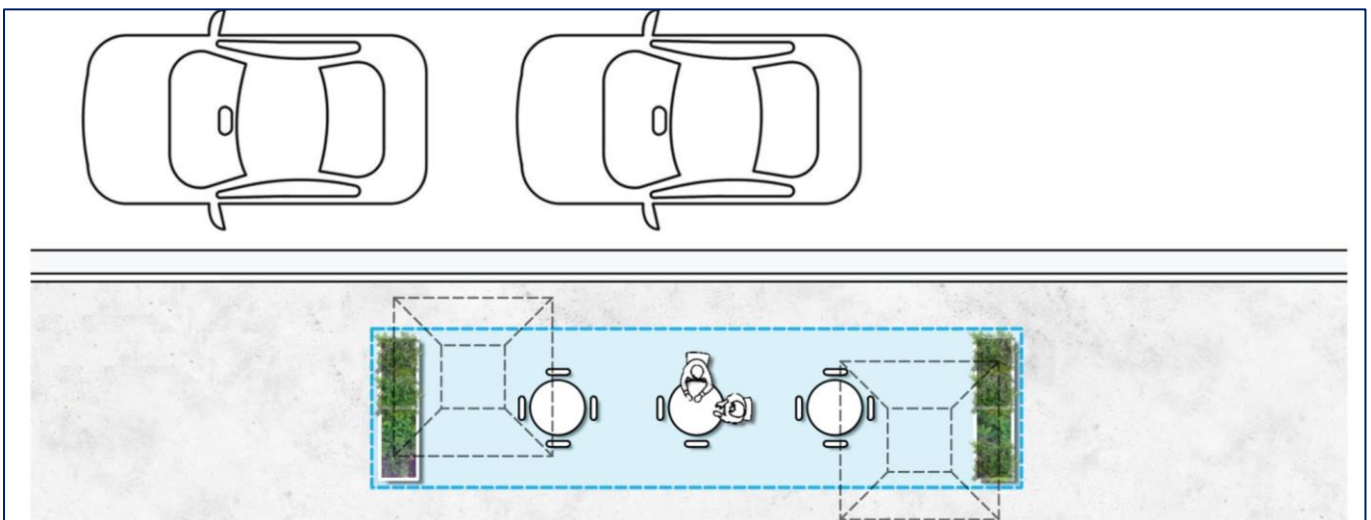

Figure 3-1: Object protrusions to outdoor dining area

- 3.5 Applications for the use of parklets in the traffic lane will be considered in certain locations. Any person wishing to install a parklet should contact CN and seek advice about the requirements and the suitability of the site.
- 3.6 Objects must be positioned and temporarily secured to ensure that they will not cause any injury to patrons or pedestrians.
- 3.7 Wiring or cabling from a business to the outdoor dining area is prohibited due to safety considerations.
- 3.8 Items placed in the outdoor dining area must not cause damage to the existing footway or other public infrastructure. The operator is responsible for any damage caused to third parties.
- 3.9 Street furniture is to be generally of metal or timber construction and be sturdy in outdoor and windy weather (see example at **Figure 3-3**).
- 3.10 Street furniture and objects are to be compatible with the surrounding streetscape and neighbourhood character, particularly when in proximity to heritage items.
- 3.11 Installation of any objects must be in accordance with manufacturer's instructions.
- 3.12 If the hours of indoor operation exceed the hours of outdoor operation, demonstration of adequate storage of outdoor furniture may be requested.

CHAIRS AND TABLES

- 3.13 A general 'rule of thumb' circulation space to cater for diners, tables and chairs is one square metre per person.

WAITER STATIONS

- 3.14 Waiter stations may be permitted where it can be demonstrated they are necessary to the operation of outdoor dining areas.
- 3.15 Waiter stations should be contained wholly within the approved outdoor dining area, mobile and designed to be unobtrusive, unobstructive and of minimalist appearance.

PERMANENT FURNITURE AND OBJECTS

- 3.16 The installation of permanent structures in the outdoor dining area (including but not limited to barriers, planter boxes, shade structures, large furniture such as picnic tables or an anchoring system), requires further approval from CN under section 126 of the *Roads Act 1993*.
- 3.17 The access and locational requirements shall meet the requirements of clause 3.3 and 3.4. Fixed furniture must not restrict access and be inclusive (see example at **Figure 3-2**)
- 3.18 Additional annual fees apply for the installation of permanent structures in the footway.
- 3.19 All permanent structures may be required to be fixed to the footway in accordance with CN's specifications. A bond may be required to be paid to CN for this installation to ensure that upon removal of the structures that the footway is not damaged. This will be determined as part of the application process.
- 3.20 All permanent structures are to be robust, durable and be maintained in a suitable condition that withstands the weather and natural elements.
- 3.21 Approvals can be revoked if the structures are considered to be unsafe, degraded or damaged.



Figure 3-2: Example of accessible permanent furniture

BARRIERS / SCREENING

- 3.22 Side or 'end', barriers which separate one venue from another are permitted. Barriers which enclose the outdoor dining area, or which separate it from the pedestrian footway 'pedestrian zone barriers', are generally not permitted.
- 3.23 There may be circumstances where extra barriers may be requested such as licenced premises or where outdoor dining areas require separation from vehicular traffic 'kerbside barriers'. See **Figure 3-4**.
- 3.24 Barriers must not exceed 1,100mm high x 600mm wide x 600mm deep and must be movable and be wholly located within the outdoor dining area, including feet and supports.
- 3.25 Barriers must be sturdy and unable to fall or be blown over and must be constructed of suitable durable materials, See **Figure 3-3**.
- 3.26 Barriers must not have any elements that can reflect light or have glare impacts.
- 3.27 Barriers must not encroach on neighbouring premises unless otherwise approved.

HEATING

- 3.28 Free standing heaters located within outdoor dining areas must comply with Australian Standard AS 4564-2004 (Radiant Gas Heaters for Outdoor and non-residential indoor use) and must be certified by the Australian Gas Association.
- 3.29 Heating devices must be contained wholly within the outdoor dining area.
- 3.30 Heating devices must be positioned to ensure that they will not cause any injury to patrons or pedestrians. Outdoor dining operators are responsible for any damage caused.

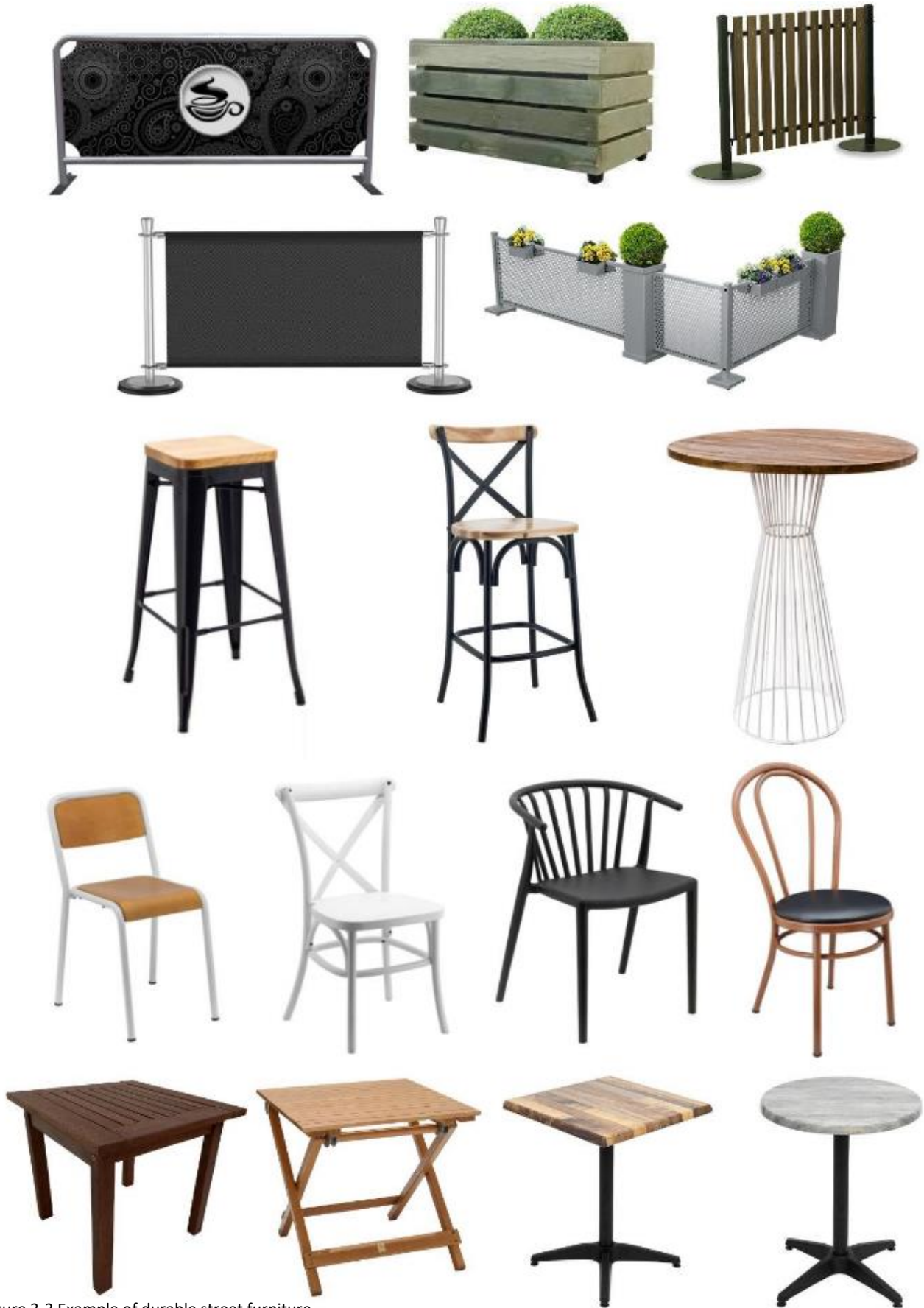

Figure 3-3 Example of durable street furniture

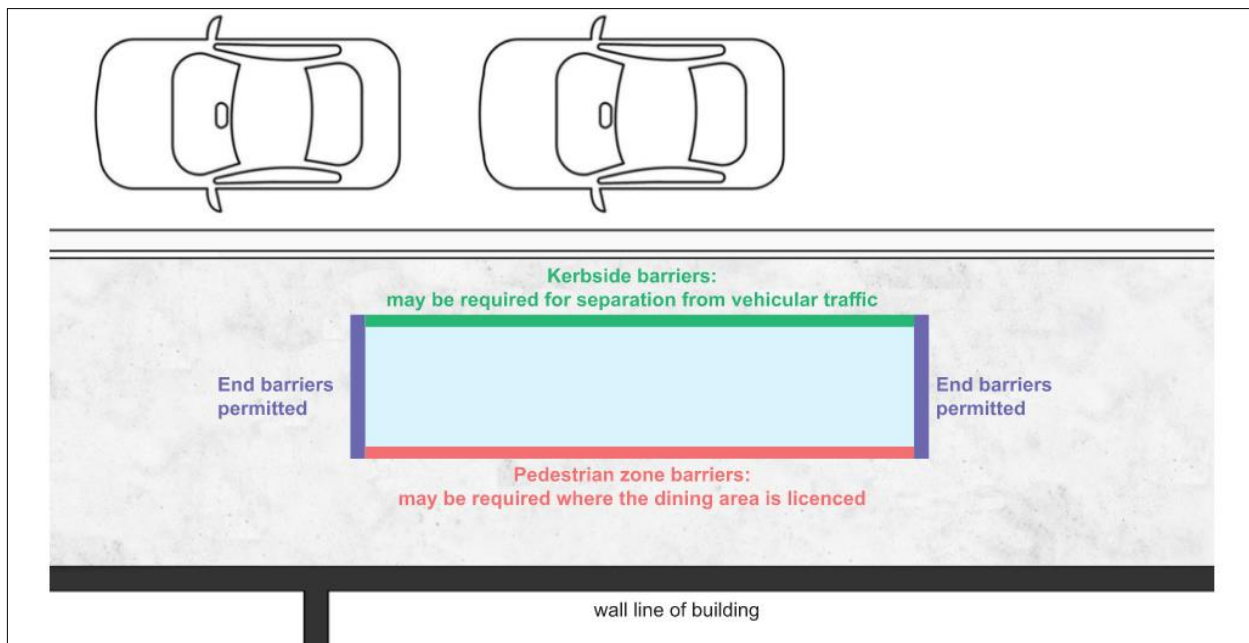

Figure 3-4 Placement of barriers

TEMPORARY SIGNAGE

- 3.31 Signage in association with outdoor dining must not cause an obstruction to pedestrian zones and are to be placed kerbside or within an outdoor dining area.
- 3.32 Venue branding may be applied to the venue's umbrellas or barrier/s where:
- Content is not offensive and relates to the associated business or products for example, logo of coffee supplier.
 - Is minor, not covering more than 30% of any surface area.
 - Does not have an adverse impact on the appearance of the dining area or streetscape.
- 3.33 Planter boxes can be used as barriers in the following circumstances:
- Compliance with the above barrier provisions.
 - Can be secured during use but removed out of hours. i.e. lockable wheels / casters.
 - Are well maintained with healthy plants and free of litter and cigarette butts.
 - Plant species are suited to planter size and location (e.g. sun or shade tolerant, indoor storage after hours).
 - Be maintained in clean condition and good repair.

- Be retractable for use only during business hours and weather events.
- Not be secured to the footway at the base during use.

WEATHER PROTECTION

- 3.34 Structures for weather protection must not obstruct sight to road signage or traffic signals.
- 3.35 Umbrellas must:
- Be secured to ensure that they are able to withstand the effects of wind and rain.
 - Have a minimum height clearance of 2.2m and be positioned to ensure that they will not cause an injury to patrons, pedestrians or other road users.
- 3.36 Drop-down blinds from overhanging structures must:
- Be of clear, durable material.
 - Be provided to a maximum of three sides of the outdoor dining area.

4. AMENITY

OBJECTIVES

The location and operation of outdoor dining area must not have an unreasonable adverse impact on the amenity of neighbours and other users of public areas.

SMOKING

Smoking in or within four metres of an outdoor dining area is prohibited when in use. The operator must display "No Smoking" signage within the outdoor dining area and abide by the *Smoke-free Environment Act 2000 (NSW)*.

SERVICE OF ALCOHOL

Where the Liquor Licence includes an outdoor dining area, alcohol may be consumed in an outdoor dining area only with the consumption of food. Primary Service of Alcohol authorisations will not be permitted by CN in outdoor dining areas. Service of alcohol is subject to any requirements of Liquor and Gaming NSW and any approval conditions imposed by CN.

Serving alcohol in an outdoor dining area in an alcohol free zone is possible providing the venue's liquor licence covers the outdoor dining area. It is recommended that suitable physical separation or barriers be provided between the dining area and the alcohol free zone.

HOURS OF OPERATION

Outdoor dining areas may only be used between the hours of 7am to 10pm, however the use cannot extend outside of:

- The hours permitted under the associated venue's DA conditions; and
- The operating hours of the kitchen.

Limited hours of operation may be imposed on the outdoor dining area if it is considered that the amenity of the surrounding area or the safety of pedestrians or outdoor diners may be adversely affected.

MUSIC & NOISE

Entertainment and amplified music are generally not permitted in outdoor dining areas.

LIGHTING

Lighting of the outdoor dining area (including decorative lighting) may be considered and / or required, with consideration to public safety and amenity, including:

- Nuisance to motorists and neighbours from glare / spillage.
- Placement of electrical cabling.
- Hours of operation.

HERITAGE

Where the proposed outdoor dining area is located in a heritage conservation area or in proximity to a heritage item, consideration must be given to compatibility with regard to materials, furniture and the like. Furniture should be of a simple, understated design which complements rather than competes with the heritage character.

MANAGEMENT

Use of public space must be responsibly managed by the operator. The outdoor dining area is to operate in accordance with these guidelines and the conditions of approval.

- A Plan of Management (POM) must be submitted with all outdoor dining applications. Refer to **Appendix B** for guidelines/requirements.

ANIMALS IN OUTDOOR DINING AREAS

An 'assistance animal' is permitted in a dining area in accordance with the *Disability Discrimination Act 1992 (Cth)*.

A dog, except a restricted or declared dangerous or menacing dog, is allowed in the outdoor dining area with the operator's consent and in accordance with the *Companion Animals Act 1998 (NSW) s14A*.

The dog may be provided with drink, but not food and the dog must be always on the ground and on a leash.

5. APPLICATION

APPLICATION REQUIREMENTS

All outdoor dining on public land requires approval from CN.

Generally, outdoor dining on a footway, in association with an existing venue is exempt development. Exempt development does not need a development application, but it does need an approval from CN under Section 125 of the *Roads Act 1993*. If unsure, applicants should talk to CN by calling 4974 2000.

Required application documents

An Application for Outdoor Dining must be submitted by email:

- business-support@ncc.nsw.gov.au. A copy of the *liquor licence* and licenced area must be submitted by all venues holding a liquor licence.
- A *Plan of Management* (POM) must be submitted with all outdoor dining applications. Refer to **Appendix B** for guidelines/ requirements. All licenced venues wishing to permit alcohol consumption outside must include information on security, management of alcohol, supervision of / line of sight to serving areas, waste management, hours of operation, noise, smoking, CCTV and amenity. A venue's existing POM can be amended to include the outdoor dining area.
- *Public liability insurance* must be held with a limit of not less than \$20,000,000 identifying 'City of Newcastle' as an Interested Party and a copy of the insurance certificate provided.
- A *site plan* of the location and outdoor dining area.
- *Photos* of the footway area.
- *Photos or brochures* of proposed furniture and outdoor dining elements (including umbrellas, planter boxes, gas heaters, etc).

- *Details and model numbers* of proposed gas heaters and/or outdoor lighting (if applicable).
- A *risk assessment* may be requested by CN if deemed necessary, such as where the proposed outdoor dining area is adjoining a moving traffic lane.
- *Neighbour consent* is required if the proposed outdoor dining area intrudes on an adjoining shopfront.
- If the outdoor dining area is located under an awning, certification from a Structural Engineer that the awning complies with the requirements set out in the Building Code of Australia, Volume 1, B1P1 and B1P2.

FEES FOR APPLICATION

Current adopted and draft fees and charges schedules are accessible at CN's website www.newcastle.nsw.gov.au. CN's Fees and Charges are reviewed annually.

The boundary markers of the outdoor dining area shall be installed and maintained by CN after approval is granted and are subject to a one-off fee.

Permanent furniture and objects within the outdoor dining area shall be subject to an annual fee.

OTHER APPROVALS

CN's Outdoor Dining Policy details the different approvals that may be required for outdoor dining. If you are not sure which approvals you require, please contact CN's Duty Officer before submitting your application.

Outdoor dining must operate in conjunction with an approved food or drink premises. A food or drink premises is defined in the Newcastle Local Environmental Plan 2012 as 'premises that are used for the preparation and retail sale of food or drink (or both) for immediate consumption on or off the premises, and includes a restaurant or cafe, take away food and drink premises, a pub or a small bar.'

The conditions of a development consent remain valid and override any provisions stated in this guideline. This includes hours of operation, venue capacity, licenced area/s. Changing your venue's capacity, operating hours or capacity requires a development application or modification to an existing development consent.

Outdoor dining on Crown land requires approval (under the Crown Lands Act 1989).

Outdoor dining that is located on private land requires a development application to be made (under the *Environmental Planning and Assessment Act 1979*).

INSURANCE

The operator must maintain a minimum of \$20 million Public Liability insurance policy. City of Newcastle, and Crown Land where necessary, must be named as an additional third party insured under the policy for its respective rights and interests. The policy must be kept valid for the duration of the Approval. CN will require a certificate of currency to verify the current insurance.



6. ASSESSMENT PROCESS

ASSESSMENT CONSIDERATIONS

CN will consider the following factors when assessing all applications for outdoor dining:

- The Local Government Act 1993, Roads Act 1993; Work Health and Safety Act 2011, Disability Discrimination Act 1992, Australia's Strategy for Protecting Crowded Places from Terrorism 2017.
- Where situated at a street intersection corner, the dining area shall reflect the appropriate principles in AustRoads Guide to Traffic Engineering Practice – Part 5 and the TfNSW's Road Design Guide with regard to the intersection typology and traffic calming infrastructure in order to maximise public safety.
- Conditions of any other current approvals (Development Consent, Liquor Licence).
- Compliance of the area with this Guideline.
- Hours of operation for the outdoor dining area will be restricted to no later than 10:00pm on any night or consistent with the DA conditions, whichever is more conservative.
- Footway condition.
- Applications for alternative placement e.g. against the building alignment, where the applicant can demonstrate that, on the merits of the individual case, the alternative arrangement will better achieve the purposes of this Policy. Consideration is to be given to the need to balance public safety against business needs and amenity considerations. Refer to the *Disability Discrimination Act 1992* (Cth) sections 23, 24 and 29A.
- Alternative placement arrangements must be consistent with other business operating outdoor dining in the same area. Inconsistent alignment of outdoor dining is not supported.

Referral agencies

Transport for NSW: An application for an outdoor dining area on a State Road with a speed limit of 60km/hr or adjacent to traffic control signals is prohibited without agreement from Transport for NSW (TfNSW). CN will seek agreement from TfNSW after an application is made by forwarding the application to TfNSW for consideration.

NSW Police: Applications for outdoor dining for premises with a liquor licence approval requires review by the NSW Police.

Notification of outdoor dining applications

Applications will be notified if the premises is located within a residential zone or in proximity to existing residential premises.

Notification will consist of publicly visible signage placed in the window of the subject venue and a notice placed on CN's website.

Applications will be publicly notified for a period of seven days.

Public notification is at the discretion of CN.

Outdoor dining applications will not be notified where:

- There is an existing outdoor dining approval.
- The application is to allow for change of operator of the outdoor dining approval.
- There are no proposed changes to the terms of the outdoor dining approval, including operating hours, and area used for outdoor dining area.

7. CONDITIONS OF APPROVAL

GENERAL

It is the responsibility of the outdoor dining operator to meet all of the conditions of an approval which may include limited operating hours. Outdoor dining operating hours are clearly identified in the outdoor dining approval.

It is the responsibility of the outdoor dining operator to ensure compliance with other approval pathways such as any Liquor Licence, DA conditions and Exempt Development.

The outdoor dining area and footway must be maintained at all times and be regularly cleaned.

All furniture in the outdoor dining area must be maintained to be physically sound and aesthetically acceptable at all times.

An approval lapses if the outdoor dining operator's business ceases to trade.

CN may revoke or suspend an approval if access is required to the footway, including construction zones or events requiring the temporary use of the footway. The approval holder / operator will be given seven days written notice whenever practical.

Despite any provisions of this Policy, CN may amend or revoke any approval to meet legislative requirements or altered circumstances at specific sites at any time. This may include instances where there are concerns for safety, or where access is required to services or utilities located within areas being used for outdoor dining.

Where an operator's Liquor Licence includes the outdoor dining area, alcohol may be consumed in an outdoor dining area only with the consumption of food. Primary Service of Alcohol authorisations will not be permitted by CN in outdoor dining areas. Service of alcohol is subject to any requirements of Liquor and Gaming NSW and any approval conditions imposed by CN.

The behaviour of patrons within the outdoor dining area is the responsibility of the business operator and is to be managed and monitored at all times, in particular at businesses operating a licensed premise.

A copy of the approved outdoor dining plan must be displayed in a prominent position for staff reference. All tables, chairs, heaters and other outdoor furniture / objects are to be kept in the designated outdoor dining area at all times. It is the responsibility of the business to ensure that patrons do not

move furniture or goods from within the boundaries of the outdoor dining area onto the pedestrian path of travel.

A copy of the outdoor dining approval and Plan of Management must be maintained on the subject premises and made available to authorised CN officers on request. It must clearly show the approved hours of operation and the approved outdoor dining area.

The operator is to bear the cost of any pavement repairs carried out by CN, caused by outdoor dining activities.

The operator is responsible for the correct storage and disposal of the business' waste and recycling. Waste cannot be swept into public property such as gutters, drains, and garden beds. Public bins may not be used for commercial waste.

The use of disposable/single-use tableware is not permitted in the outdoor dining area.

Any heating and lighting devices must be approved by CN.

Markers

The outdoor dining area is to be clearly marked and defined. Outdoor dining is only allowed within the approved area. CN will install markers after the approval of an outdoor dining application.

Crime prevention

It is the responsibility of the operator of the business with an approved outdoor dining area to monitor anti-social behaviour and activities being undertaken, or activities which are contrary to the approval.

Notification of claims

The applicant / operator is required to submit a copy of their current Public Liability Certificate of currency to CN, prior to the placement of furniture within the approved outdoor dining area and with each renewal.

The operator of an outdoor dining area must immediately notify CN should any claim be made against them.

Operators must at all times have continuous Public Liability Insurance.

Transferring an approval

Current outdoor dining approvals cannot be transferred when an existing business is sold to a new proprietor or when a new business begins operating at a property.

A new application must be submitted via email at business-support@ncc.nsw.gov.au

Renewals

Approvals may be renewed at the expiration period, which will be in line with the operator's public liability insurance.

CN will notify existing operators of the upcoming expiration of an existing outdoor dining approval and will invite operators to renew their approval.

Operators will be required to advise CN whether they intend to renew their outdoor dining or allow it to expire. If renewed, the outdoor dining approval is valid for another 12 months.

Renewal applications will require an updated current Certificate of Currency for Public Liability Insurance.

Permit holders that commenced operation of their outdoor dining approval under the previous Outdoor Trading Policy, or any earlier Policy, will need to ensure their outdoor dining area meets the minimum standards set out in these guidelines upon renewal.

COMPLIANCE

The use of an outdoor dining area without a valid approval is an offence and may result in the commencement of regulatory action as outlined in CN's Compliance and Enforcement Policy.

Authorised CN officers may order the removal of any items on the footway that are not part of the outdoor dining approval, or otherwise permitted under another approval or policy of CN.

The use of an outdoor dining area will be reviewed if the use is not in accordance with the conditions of approval.

Any breach of an approval may result in the commencement of regulatory action as outlined in CN's Compliance and Enforcement Policy.

Any complaints arising from the operation of an outdoor dining area will be investigated and managed in accordance with Compliance and Enforcement Policy and/or CN's Customer Complaints Handling Policy.



IMAGE: NSW OUTDOOR DINING GUIDELINES

Appendix A: **Site Plan Example**

Example Site Plan per requirements of clause 4



Legend

- Street Furniture - seats, bins etc
- Existing tree pit
- Table and Chairs
- Umbrella - 2.2m above footway
- planter box
- outdoor dining area

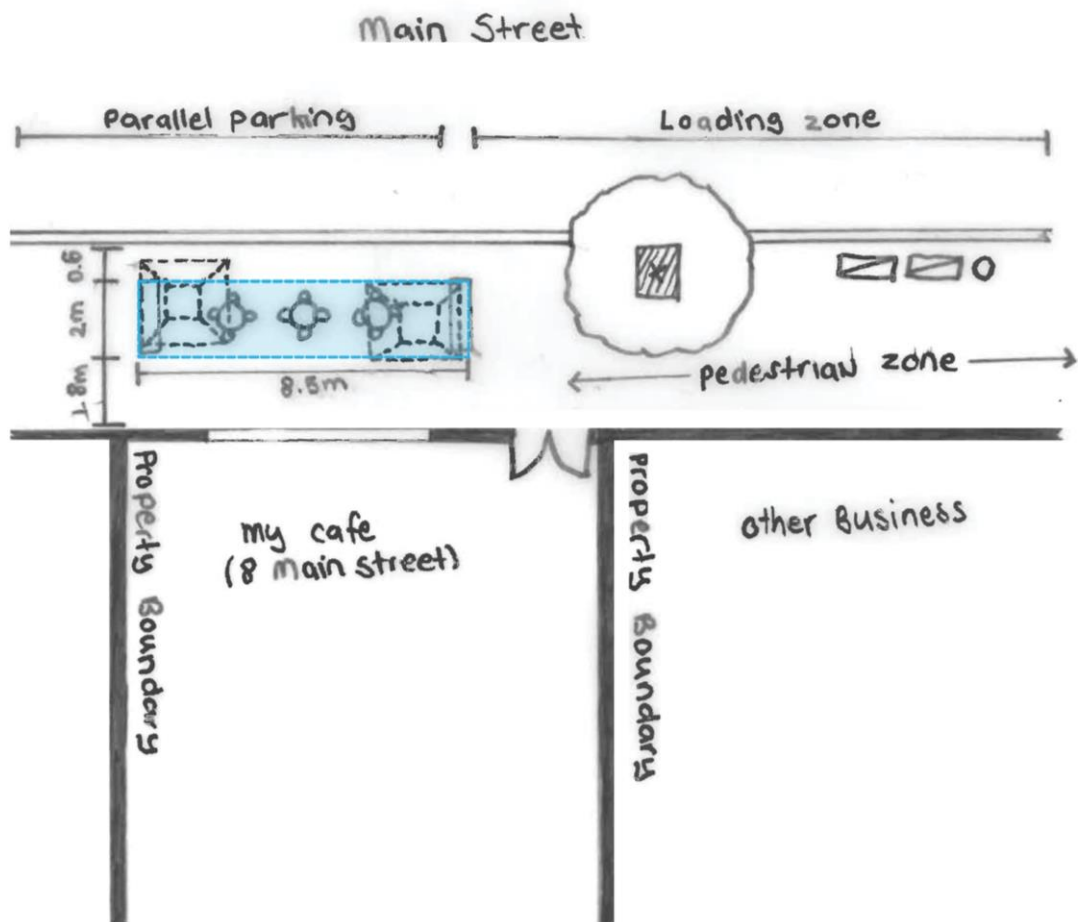

Appendix B: **Plan of Management Requirements**

Outdoor Dining Plan of Management Requirements

Minimum information that is required to be included in a Plan of Management (POM):

- The name and address of the premises.
- The hours of operation sought for the outdoor dining area and the hours of operation of the existing or proposed food and drink premises.
- The capacity of the outdoor dining area, reflected as seats.

Use of outdoor dining area/general management of space

The POM should include a section in which the operator clearly states an understanding that the outdoor dining area is to be used principally for dining purposes and the service of alcohol is ancillary to this main purpose, and smoking within a designated dining area is prohibited. This should be articulated that it will be communicated to staff and or training will be provided so that all staff understand the responsibility to enforce the use of this area.

Surveillance

The premises may include an existing built form which can often constrain sightlines from the internal restaurant area or bar (or in some cases almost entirely from the internal space) to the footpath area on which the outdoor dining is to be located.

It is essential that detail is provided as to how adequate surveillance of the outdoor dining area will be facilitated. This can be achieved through mechanical surveillance through the installation of CCTV that would be monitored consistently or by a nominated staff member doing 'rounds' of the designated outdoor dining area in order to ensure that the area is being used appropriately (within the terms of CN Policy), for example the POM may detail 15 minute rounds to a nominated staff member.

Alcohol and safety

The POM should detail how the dining area will be maintained in a clean and tidy fashion. If alcohol is to be served in the outdoor dining area, it is important that empty glasses and bottles are removed promptly to minimise any anti-social behaviour or accidents in the public domain.

Signage

The POM should detail required signage to be implemented within the space to the effect of:

- Please respect the amenity of surrounding residents by minimising noise.
- No smoking signs.

Storage of Furniture

The POM must detail that the furniture will be removed from the area at the completion of outdoor dining at the end of trading and stored within the premises, if permanent structures have not been approved. The designated storage space for the furniture should be shown on the plan or clearly identified in the POM.

Complaints Register

The POM should include the acknowledgement that a complaints register will be established for the purposes of complaints emanating from the outdoor dining area or the business operation. If the premises has a current liquor licence, an Incident Register for the premises may exist and this can be used to keep records of complaints about the outdoor dining area.

Noise

The POM should contain a statement from the operator of the premises how they will manage noise emanating from the outdoor dining area.

Waste

The POM should contain a statement on how waste will be managed and how the outdoor dining area will be maintained regularly.